

PTPOWER 50 OG - High-current terminal block



3260069

<https://www.phoenixcontact.com/sg/products/3260069>

Please be informed that the data shown in this PDF document is generated from our online catalog. Please find the complete data in the user documentation. Our general terms of use for downloads are valid.



High-current terminal block, nom. voltage: 1000 V, nominal current: 150 A, number of connections: 2, number of positions: 1, connection method: PowerTurn connection, 1 level, cross section: 10 mm² - 70 mm², mounting type: NS 35/15, color: orange

Your advantages

- Quick and easy connection is now also possible for large conductors with the high-current terminal block
- In addition to using the existing test pick-off, pick-off terminal blocks can be connected, each of which can also accommodate two test cables
- The Push-in connection terminal blocks are characterized by the system features of the CLIPLINE complete system and by easy and tool-free wiring of conductors with ferrules or solid conductors
- The compact design enables wiring in a confined space

Commercial data

Item number	3260069
Packing unit	10 pc
Minimum order quantity	10 pc
Sales key	*****
Product key	BE2211
GTIN	4055626230535
Weight per piece (including packing)	157.29 g
Weight per piece (excluding packing)	157.29 g
Customs tariff number	85369010
Country of origin	PL

PTPOWER 50 OG - High-current terminal block



3260069

<https://www.phoenixcontact.com/sg/products/3260069>

Technical data

Product properties

Product type	High current terminal block
Number of positions	1
Number of connections	2
Number of rows	1
Potentials	1

Insulation characteristics

Overvoltage category	III
Degree of pollution	3

Electrical properties

Rated surge voltage	8 kV
Maximum power dissipation for nominal condition	4.73 W

Connection data

Number of connections per level	2
Nominal cross section	50 mm ²
Rated cross section AWG	2/0

1 level

Stripping length	30 mm ... 32 mm
Internal cylindrical gage	A10
Connection in acc. with standard	IEC 60947-7-1
Conductor cross section rigid	10 mm ² ... 70 mm ²
Cross section AWG	6 ... 2/0 (converted acc. to IEC)
Conductor cross section flexible	10 mm ² ... 70 mm ²
Conductor cross section, flexible [AWG]	6 ... 2/0 (converted acc. to IEC)
Conductor cross-section flexible (ferrule without plastic sleeve)	10 mm ² ... 50 mm ²
Flexible conductor cross section (ferrule with plastic sleeve)	10 mm ² ... 50 mm ²
Cross-section with insertion bridge, rigid	10 mm ² ... 50 mm ²
Cross-section with insertion bridge, flexible	10 mm ² ... 50 mm ²
Cross-section with insertion bridge, flexible, with ferrule without plastic sleeve	10 mm ² ... 50 mm ²
Cross-section with insertion bridge, flexible, with ferrule with plastic sleeve	10 mm ² ... 50 mm ²
Nominal current	150 A
Maximum load current	150 A (with 70 mm ² conductor cross section)
Nominal voltage	1000 V

1 level Connection cross sections directly pluggable

Conductor cross section rigid	10 mm ² ... 70 mm ²
Conductor cross section, rigid [AWG]	8 ... 2/0 (converted acc. to IEC)

PTPOWER 50 OG - High-current terminal block



3260069

<https://www.phoenixcontact.com/sg/products/3260069>

Conductor cross-section flexible (ferrule without plastic sleeve)	10 mm ² ... 50 mm ²
Flexible conductor cross section (ferrule with plastic sleeve)	10 mm ² ... 50 mm ²

Ex data

Rated data (ATEX/IECEX)

Identification	⊕ II 2 GD Ex eb IIC Gb
Operating temperature range	-60 °C ... 110 °C
Ex-certified accessories	1206612 SZF 3-1,0X5,5 1201662 E/AL-NS 35
List of bridges	/ EB 2-20/PT / 3260067 / EB 3-20/PT / 3260068
Bridge data	131 A (50 mm ²)
Ex temperature increase	40 K (147 A / 50 mm ²)
Rated voltage	1100 V
at bridging with insertion bridge	1100 V
Rated insulation voltage	1000 V
output	(Permanent)

Ex level General

Rated current	134 A
Maximum load current	134 A
Contact resistance	0.16 mΩ

Ex connection data General

Ferrule length	30 mm ... 32 mm
Stripping length	30 mm
Nominal cross section	50 mm ²
Rated cross section AWG	1/0
Connection capacity rigid	10 mm ² ... 70 mm ²
Connection capacity AWG	8 ... 2/0
Conductor cross section flexible, with ferrule without plastic sleeve min.	16 mm ²
Conductor cross section flexible, with ferrule without plastic sleeve max.	50 mm ²

Dimensions

Width	20 mm
Height	101 mm
Depth on NS 35/15	105 mm

Material specifications

Color	orange (RAL 2003)
Flammability rating according to UL 94	V0
Insulating material group	I
Insulating material	PA

PTPOWER 50 OG - High-current terminal block



3260069

<https://www.phoenixcontact.com/sg/products/3260069>

Mechanical properties

Mechanical data

Open side panel	No
-----------------	----

Environmental and real-life conditions

Ambient conditions

Ambient temperature (operation)	-60 °C ... 110 °C (Operating temperature range incl. self-heating; for max. short-term operating temperature, see RTI Elec.)
Ambient temperature (storage/transport)	-25 °C ... 60 °C (for a short time, not exceeding 24 h, -60 °C to +70 °C)
Ambient temperature (assembly)	-5 °C ... 70 °C
Ambient temperature (actuation)	-5 °C ... 70 °C
Permissible humidity (operation)	20 % ... 90 %
Permissible humidity (storage/transport)	30 % ... 70 %

Standards and regulations

Connection in acc. with standard	IEC 60947-7-1
----------------------------------	---------------

Mounting

Mounting type	NS 35/15
---------------	----------

PTPOWER 50 OG - High-current terminal block

3260069

<https://www.phoenixcontact.com/sg/products/3260069>

Drawings

Schematic diagram

PTPOWER

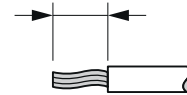

AGK 10-PTPOWER	0,5 mm ² ... 16 mm ²	18 mm
PTPOWER 35	2,5 mm ² ... 35 mm ²	25 mm
PTPOWER 50	10 mm ² ... 50 mm ²	32 mm
PTPOWER 95	25 mm ² ... 95 mm ²	40 mm
PTPOWER 185	95 mm ² ... 185 mm ²	40 mm

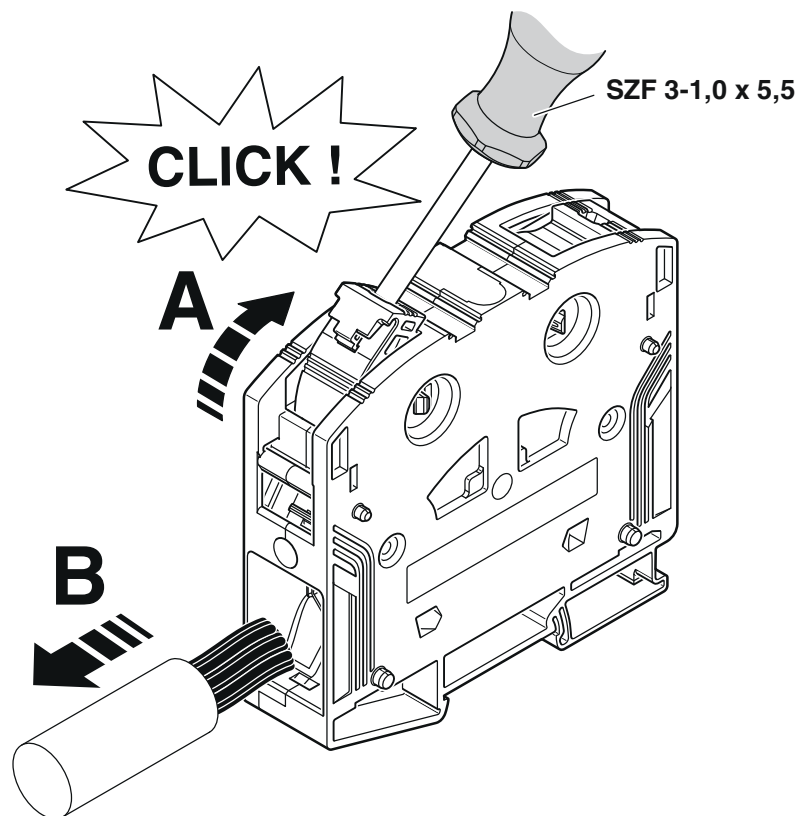

PPOWER 50 OG - High-current terminal block



3260069

<https://www.phoenixcontact.com/sg/products/3260069>

Circuit diagram



PTPOWER 50 OG - High-current terminal block





3260069

<https://www.phoenixcontact.com/sg/products/3260069>

Approvals

To download certificates, visit the product detail page: <https://www.phoenixcontact.com/sg/products/3260069>

 CSA Approval ID: 13631				
	Nominal voltage U_N	Nominal current I_N	Cross section AWG	Cross section mm^2
Use group B	600 V	140 A	8 - 1/0	-
Use group C	1000 V	140 A	8 - 1/0	-

 cUL Recognized Approval ID: E60425				
	Nominal voltage U_N	Nominal current I_N	Cross section AWG	Cross section mm^2
Use group C	1000 V	140 A	8 - 1/0	-

 UL Recognized Approval ID: E60425				
	Nominal voltage U_N	Nominal current I_N	Cross section AWG	Cross section mm^2
Use group E	1000 V	140 A	8 - 1/0	-

DNV Approval ID: TAE00000Z9				
---------------------------------------	--	--	--	--

 CCC Approval ID: 2020322313000630				
---	--	--	--	--

 UKCA-EX Approval ID: CML 22UKEX1227U				
--	--	--	--	--

 IECEX Approval ID: IECEXSEV14.0013U				
---	--	--	--	--

 ATEX Approval ID: SEV14ATEX0156U				
	Nominal voltage U_N	Nominal current I_N	Cross section AWG	Cross section mm^2
Only rigid conductors	1100 V	134 A	-	10 - 70

PTPOWER 50 OG - High-current terminal block



3260069

<https://www.phoenixcontact.com/sg/products/3260069>

multi-stranded with ferrule	1100 V	134 A	-	16 - 50
-----------------------------	--------	-------	---	---------

 IECEx Approval ID: IECExSEV14.0013U				
	Nominal voltage U_N	Nominal current I_N	Cross section AWG	Cross section mm^2
	1100 V	134 A	-	-
Only rigid conductors	1100 V	134 A	-	-
multi-stranded with ferrule	1100 V	134 A	-	-

 EAC Ex Approval ID: KZ 7500525010101950				
---	--	--	--	--

cULus Recognized

PTPOWER 50 OG - High-current terminal block



3260069

<https://www.phoenixcontact.com/sg/products/3260069>

Classifications

ECLASS

ECLASS-11.0	27141120
ECLASS-13.0	27250101

ETIM

ETIM 9.0	EC000897
----------	----------

UNSPSC

UNSPSC 21.0	39121400
-------------	----------

PTPOWER 50 OG - High-current terminal block



3260069

<https://www.phoenixcontact.com/sg/products/3260069>

Environmental product compliance

EU RoHS

Fulfills EU RoHS substance requirements	Yes, No exemptions
---	--------------------

China RoHS

Environment friendly use period (EFUP)	EFUP-E
	No hazardous substances above the limits

EU REACH SVHC

REACH candidate substance (CAS No.)	No substance above 0.1 wt%
-------------------------------------	----------------------------

Phoenix Contact 2025 © - all rights reserved
<https://www.phoenixcontact.com>

PHOENIX CONTACT SEA Pte. Ltd.
105 Eunos Avenue 3, #04-00
Singapore 409836
+65 6228 4900
marketing@phoenixcontact.com.sg