

# PTPOWER 185 3L/FE-F - High-current terminal block



1054737

<https://www.phoenixcontact.com/sg/products/1054737>

Please be informed that the data shown in this PDF document is generated from our online catalog. Please find the complete data in the user documentation. Our general terms of use for downloads are valid.



High-current terminal block, Blocked, nom. voltage: 1000 V, nominal current: 309 A, number of connections: 8, number of positions: 4, connection method: PowerTurn connection, 1 level, cross section: 95 mm<sup>2</sup> - 185 mm<sup>2</sup>, mounting type: direct screw connection, color: gray/black-yellow

## Your advantages

- Quick and easy connection is now also possible for large conductors with the high-current terminal block
- In addition to using the existing test pick-off, pick-off terminal blocks can be connected, each of which can also accommodate two test cables
- The Push-in connection terminal blocks are characterized by the system features of the CLIPLINE complete system and by easy and tool-free wiring of conductors with ferrules or solid conductors
- The compact design enables wiring in a confined space

## Commercial data

Item number	1054737
Packing unit	1 pc
Minimum order quantity	1 pc
Sales key	*****
Product key	BE2211
Catalog page	Page 141 (C-1-2019)
GTIN	4055626690452
Weight per piece (including packing)	1,414.1 g
Weight per piece (excluding packing)	1,414 g
Customs tariff number	85369010
Country of origin	PL

1054737

<https://www.phoenixcontact.com/sg/products/1054737>

## Technical data

### Product properties

Product type	High current terminal block
Number of positions	4
Pitch	31 mm
Number of connections	8
Number of rows	1
Potentials	4

### Insulation characteristics

Overvoltage category	III
Degree of pollution	3

### Electrical properties

Rated surge voltage	8 kV
Maximum power dissipation for nominal condition	9.55 W

### Connection data

Number of connections per level	8
Nominal cross section	150 mm <sup>2</sup>

#### 1 level

Stripping length	40 mm
Internal cylindrical gage	B14
Connection in acc. with standard	IEC 60947-7-1
Conductor cross section rigid	95 mm <sup>2</sup> ... 185 mm <sup>2</sup>
Cross section AWG	250 kcmil ... 350 kcmil (converted acc. to IEC)
Conductor cross section flexible	95 mm <sup>2</sup> ... 185 mm <sup>2</sup>
Conductor cross section, flexible [AWG]	250 kcmil ... 350 kcmil (converted acc. to IEC)
Conductor cross-section flexible (ferrule without plastic sleeve)	95 mm <sup>2</sup> ... 150 mm <sup>2</sup>
Flexible conductor cross section (ferrule with plastic sleeve)	95 mm <sup>2</sup> ... 150 mm <sup>2</sup>
Cross-section with insertion bridge, rigid	95 mm <sup>2</sup> ... 150 mm <sup>2</sup>
Cross-section with insertion bridge, flexible	95 mm <sup>2</sup> ... 150 mm <sup>2</sup>
Cross-section with insertion bridge, flexible, with ferrule without plastic sleeve	95 mm <sup>2</sup> ... 120 mm <sup>2</sup>
Cross-section with insertion bridge, flexible, with ferrule with plastic sleeve	95 mm <sup>2</sup> ... 120 mm <sup>2</sup>
Nominal current	309 A
Maximum load current	309 A (with 150 mm <sup>2</sup> conductor cross section)
Nominal voltage	1000 V

#### 1 level Connection cross sections directly pluggable

Conductor cross section rigid	95 mm <sup>2</sup> ... 185 mm <sup>2</sup>
Conductor cross-section flexible (ferrule without plastic sleeve)	95 mm <sup>2</sup> ... 150 mm <sup>2</sup>

# PTPOWER 185 3L/FE-F - High-current terminal block



1054737

<https://www.phoenixcontact.com/sg/products/1054737>

Flexible conductor cross section (ferrule with plastic sleeve)	95 mm <sup>2</sup> ... 150 mm <sup>2</sup>
--	--

## Dimensions

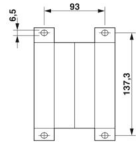
Dimensional drawing	
Width	124 mm
Height	150 mm
Depth	108.3 mm
Drill hole spacing	126.4 mm
Hole diameter	6.5 mm
Pitch	31 mm

## Material specifications

Color	multicolored gray (RAL 7042) black (RAL 9005) yellow (RAL 1018)
Flammability rating according to UL 94	V0
Insulating material group	I
Insulating material	PA

## Mechanical properties

### Mechanical data

Open side panel	No
-----------------	----

### Technical data

Drill hole spacing	126.4 mm
--------------------	----------

## Environmental and real-life conditions

### Ambient conditions

Ambient temperature (operation)	-60 °C ... 110 °C (Operating temperature range incl. self-heating; for max. short-term operating temperature, see RTI Elec.)
Ambient temperature (storage/transport)	-25 °C ... 60 °C (for a short time, not exceeding 24 h, -60 °C to +70 °C)
Ambient temperature (assembly)	-5 °C ... 70 °C
Ambient temperature (actuation)	-5 °C ... 70 °C
Permissible humidity (operation)	20 % ... 90 %
Permissible humidity (storage/transport)	30 % ... 70 %

## Standards and regulations

Connection in acc. with standard	IEC 60947-7-1
----------------------------------	---------------

# PPOWER 185 3L/FE-F - High-current terminal block



1054737

<https://www.phoenixcontact.com/sg/products/1054737>

## Mounting

Mounting type
direct screw connection

# PPOWER 185 3L/FE-F - High-current terminal block



1054737

<https://www.phoenixcontact.com/sg/products/1054737>

## Drawings

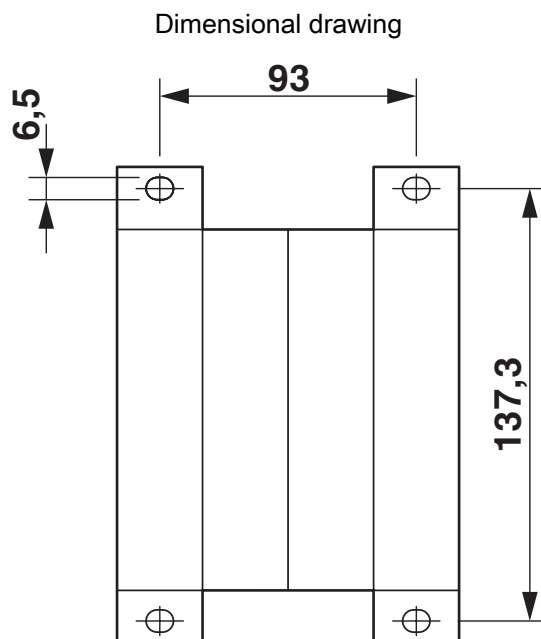

# PTPOWER 185 3L/FE-F - High-current terminal block

1054737

<https://www.phoenixcontact.com/sg/products/1054737>

Schematic diagram

## PTPOWER



AGK 10-PTPOWER	0,5 mm <sup>2</sup> ... 16 mm <sup>2</sup>	18 mm
PTPOWER 35	2,5 mm <sup>2</sup> ... 35 mm <sup>2</sup>	25 mm
PTPOWER 50	10 mm <sup>2</sup> ... 50 mm <sup>2</sup>	32 mm
PTPOWER 95	25 mm <sup>2</sup> ... 95 mm <sup>2</sup>	40 mm
PTPOWER 185	95 mm <sup>2</sup> ... 185 mm <sup>2</sup>	40 mm

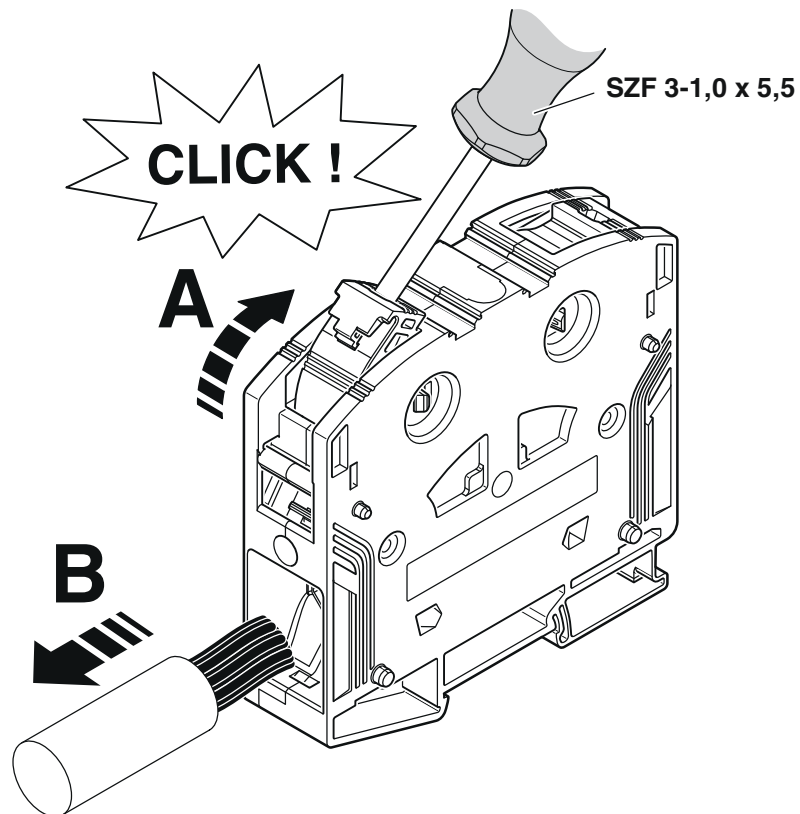

# PPOWER 185 3L/FE-F - High-current terminal block



1054737

<https://www.phoenixcontact.com/sg/products/1054737>

Circuit diagram

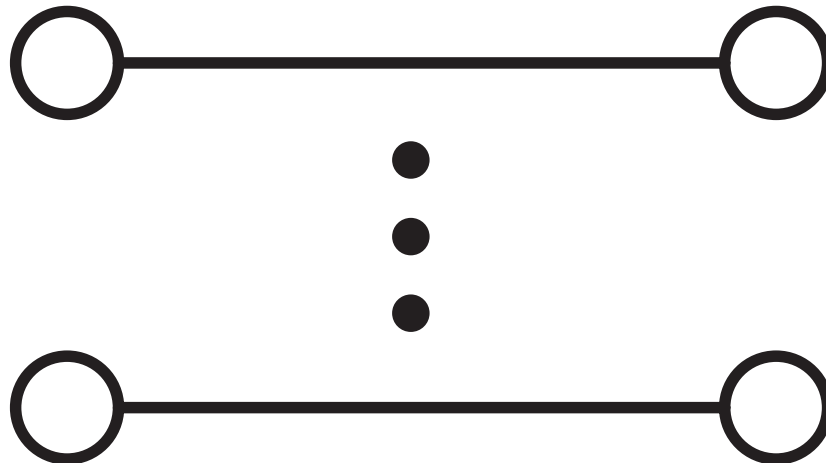

# PTPOWER 185 3L/FE-F - High-current terminal block





1054737

<https://www.phoenixcontact.com/sg/products/1054737>

## Approvals

To download certificates, visit the product detail page: <https://www.phoenixcontact.com/sg/products/1054737>

 <b>UL Recognized</b> Approval ID: E60425				
	Nominal voltage $U_N$	Nominal current $I_N$	Cross section AWG	Cross section $\text{mm}^2$
Use group F	1000 V	290 A	3/0 - 350	-
Use group E	1000 V	290 A	3/0 - 350	-

 <b>EAC</b> Approval ID: RU C-DE.BL08.B.00644				
---	--	--	--	--

<b>DNV</b> Approval ID: TAE00000Z9				
---------------------------------------	--	--	--	--

 <b>EAC</b> Approval ID: EACKZ 08593				
--	--	--	--	--



# PTPOWER 185 3L/FE-F - High-current terminal block



1054737

<https://www.phoenixcontact.com/sg/products/1054737>

## Classifications

### ECLASS

ECLASS-11.0	27141120
ECLASS-13.0	27250101

### ETIM

ETIM 9.0	EC000897
----------	----------

### UNSPSC

UNSPSC 21.0	39121400
-------------	----------

# PTPOWER 185 3L/FE-F - High-current terminal block



1054737

<https://www.phoenixcontact.com/sg/products/1054737>

## Environmental product compliance

### EU RoHS

Fulfills EU RoHS substance requirements	Yes, No exemptions
---	--------------------

### China RoHS

Environment friendly use period (EFUP)	EFUP-E
	No hazardous substances above the limits

### EU REACH SVHC

REACH candidate substance (CAS No.)	No substance above 0.1 wt%
-------------------------------------	----------------------------

Phoenix Contact 2025 © - all rights reserved  
<https://www.phoenixcontact.com>

PHOENIX CONTACT SEA Pte. Ltd.  
105 Eunos Avenue 3, #04-00  
Singapore 409836  
+65 6228 4900  
[marketing@phoenixcontact.com.sg](mailto:marketing@phoenixcontact.com.sg)