

PTPOWER 185 3L/N-F - High-current terminal block



1054736

<https://www.phoenixcontact.com/sg/products/1054736>

Please be informed that the data shown in this PDF document is generated from our online catalog. Please find the complete data in the user documentation. Our general terms of use for downloads are valid.



High-current terminal block, Blocked, nom. voltage: 1000 V, nominal current: 309 A, number of connections: 8, number of positions: 4, connection method: PowerTurn connection, 1 level, cross section: 95 mm² - 185 mm², mounting type: direct screw connection, color: gray/blue

Your advantages

- Quick and easy connection is now also possible for large conductors with the high-current terminal block
- In addition to using the existing test pick-off, pick-off terminal blocks can be connected, each of which can also accommodate two test cables
- The compact design enables wiring in a confined space
- The Push-in connection terminal blocks are characterized by the system features of the CLIPLINE complete system and by easy and tool-free wiring of conductors with ferrules or solid conductors

Commercial data

Item number	1054736
Packing unit	1 pc
Minimum order quantity	1 pc
Sales key	*****
Product key	BE2211
Catalog page	Page 141 (C-1-2019)
GTIN	4055626690872
Weight per piece (including packing)	1,391 g
Weight per piece (excluding packing)	1,391 g
Customs tariff number	85369010
Country of origin	PL

PTPOWER 185 3L/N-F - High-current terminal block



1054736

<https://www.phoenixcontact.com/sg/products/1054736>

Technical data

Product properties

Product type	High current terminal block
Number of positions	4
Pitch	31 mm
Number of connections	8
Number of rows	1
Potentials	4

Insulation characteristics

Overvoltage category	III
Degree of pollution	3

Electrical properties

Rated surge voltage	8 kV
Maximum power dissipation for nominal condition	9.55 W

Connection data

Number of connections per level	8
Nominal cross section	150 mm ²

1 level

Stripping length	40 mm
Internal cylindrical gage	B14
Connection in acc. with standard	IEC 60947-7-1
Conductor cross section rigid	95 mm ² ... 185 mm ²
Cross section AWG	250 kcmil ... 350 kcmil (converted acc. to IEC)
Conductor cross section flexible	95 mm ² ... 185 mm ²
Conductor cross section, flexible [AWG]	250 kcmil ... 350 kcmil (converted acc. to IEC)
Conductor cross-section flexible (ferrule without plastic sleeve)	95 mm ² ... 150 mm ²
Flexible conductor cross section (ferrule with plastic sleeve)	95 mm ² ... 150 mm ²
Cross-section with insertion bridge, rigid	95 mm ² ... 150 mm ²
Cross-section with insertion bridge, flexible	95 mm ² ... 150 mm ²
Cross-section with insertion bridge, flexible, with ferrule without plastic sleeve	95 mm ² ... 120 mm ²
Cross-section with insertion bridge, flexible, with ferrule with plastic sleeve	95 mm ² ... 120 mm ²
Nominal current	309 A
Maximum load current	309 A (with 150 mm ² conductor cross section)
Nominal voltage	1000 V

1 level Connection cross sections directly pluggable

Conductor cross section rigid	95 mm ² ... 185 mm ²
Conductor cross-section flexible (ferrule without plastic sleeve)	95 mm ² ... 150 mm ²

PTPOWER 185 3L/N-F - High-current terminal block



1054736

<https://www.phoenixcontact.com/sg/products/1054736>

Flexible conductor cross section (ferrule with plastic sleeve)	95 mm ² ... 150 mm ²
--	--

Dimensions

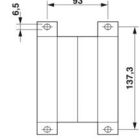
Dimensional drawing	
Width	124 mm
Height	150 mm
Depth	108.3 mm
Drill hole spacing	137.2 mm
Hole diameter	6.5 mm
Pitch	31 mm

Material specifications

Color	multicolored gray (RAL 7042) blue (RAL 5015)
Flammability rating according to UL 94	V0
Insulating material group	I
Insulating material	PA

Mechanical properties

Mechanical data

Open side panel	No
-----------------	----

Technical data

Drill hole spacing	137.2 mm
--------------------	----------

Environmental and real-life conditions

Ambient conditions

Ambient temperature (operation)	-60 °C ... 110 °C (Operating temperature range incl. self-heating; for max. short-term operating temperature, see RTI Elec.)
Ambient temperature (storage/transport)	-25 °C ... 60 °C (for a short time, not exceeding 24 h, -60 °C to +70 °C)
Ambient temperature (assembly)	-5 °C ... 70 °C
Ambient temperature (actuation)	-5 °C ... 70 °C
Permissible humidity (operation)	20 % ... 90 %
Permissible humidity (storage/transport)	30 % ... 70 %

Standards and regulations

Connection in acc. with standard	IEC 60947-7-1
----------------------------------	---------------

Mounting

PPOWER 185 3L/N-F - High-current terminal block



1054736

<https://www.phoenixcontact.com/sg/products/1054736>

Mounting type	direct screw connection
---------------	-------------------------

PPOWER 185 3L/N-F - High-current terminal block

1054736

<https://www.phoenixcontact.com/sg/products/1054736>



Drawings

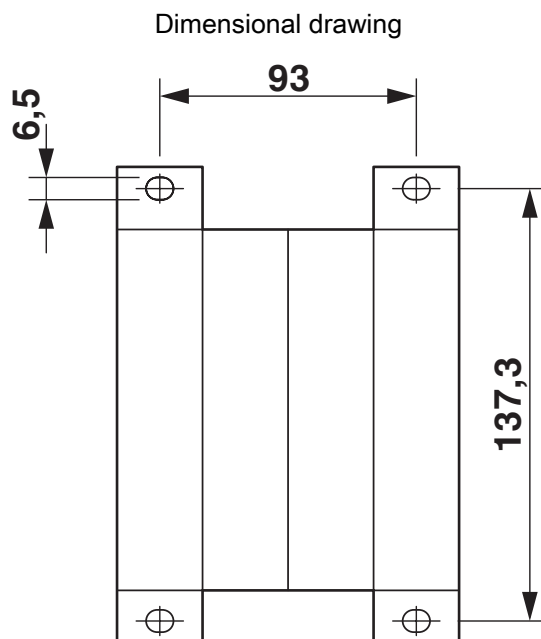

PTPOWER 185 3L/N-F - High-current terminal block

1054736

<https://www.phoenixcontact.com/sg/products/1054736>

Schematic diagram

PTPOWER



AGK 10-PTPOWER	0,5 mm ² ... 16 mm ²	18 mm
PTPOWER 35	2,5 mm ² ... 35 mm ²	25 mm
PTPOWER 50	10 mm ² ... 50 mm ²	32 mm
PTPOWER 95	25 mm ² ... 95 mm ²	40 mm
PTPOWER 185	95 mm ² ... 185 mm ²	40 mm

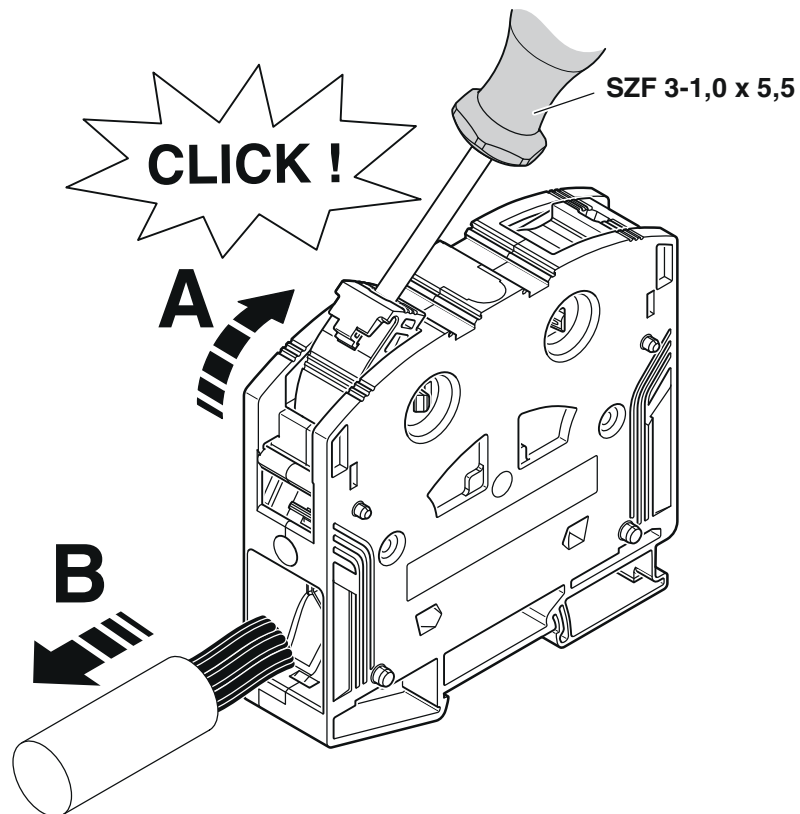

PPOWER 185 3L/N-F - High-current terminal block



1054736

<https://www.phoenixcontact.com/sg/products/1054736>

Circuit diagram

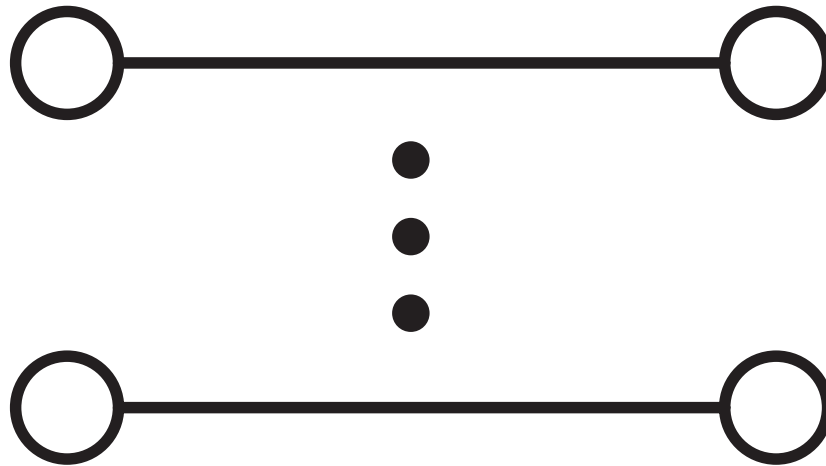

PTPOWER 185 3L/N-F - High-current terminal block





1054736

<https://www.phoenixcontact.com/sg/products/1054736>

Approvals

To download certificates, visit the product detail page: <https://www.phoenixcontact.com/sg/products/1054736>

 UL Recognized Approval ID: E60425				
	Nominal voltage U_N	Nominal current I_N	Cross section AWG	Cross section mm^2
Use group F	1000 V	290 A	3/0 - 350	-
Use group E	1000 V	290 A	3/0 - 350	-

 EAC Approval ID: RU C-DE.BL08.B.00644				
---	--	--	--	--

 DNV Approval ID: TAE00000Z9				
---	--	--	--	--

 EAC Approval ID: EACKZ 08593				
--	--	--	--	--

PTPOWER 185 3L/N-F - High-current terminal block



1054736

<https://www.phoenixcontact.com/sg/products/1054736>

Classifications

ECLASS

ECLASS-11.0	27141120
ECLASS-13.0	27250101

ETIM

ETIM 9.0	EC000897
----------	----------

UNSPSC

UNSPSC 21.0	39121400
-------------	----------

PTPOWER 185 3L/N-F - High-current terminal block



1054736

<https://www.phoenixcontact.com/sg/products/1054736>

Environmental product compliance

EU RoHS

Fulfills EU RoHS substance requirements	Yes, No exemptions
---	--------------------

China RoHS

Environment friendly use period (EFUP)	EFUP-E
	No hazardous substances above the limits

EU REACH SVHC

REACH candidate substance (CAS No.)	No substance above 0.1 wt%
-------------------------------------	----------------------------

Phoenix Contact 2025 © - all rights reserved
<https://www.phoenixcontact.com>

PHOENIX CONTACT SEA Pte. Ltd.
105 Eunos Avenue 3, #04-00
Singapore 409836
+65 6228 4900
marketing@phoenixcontact.com.sg